

Pneumatic press Model EXPLORER

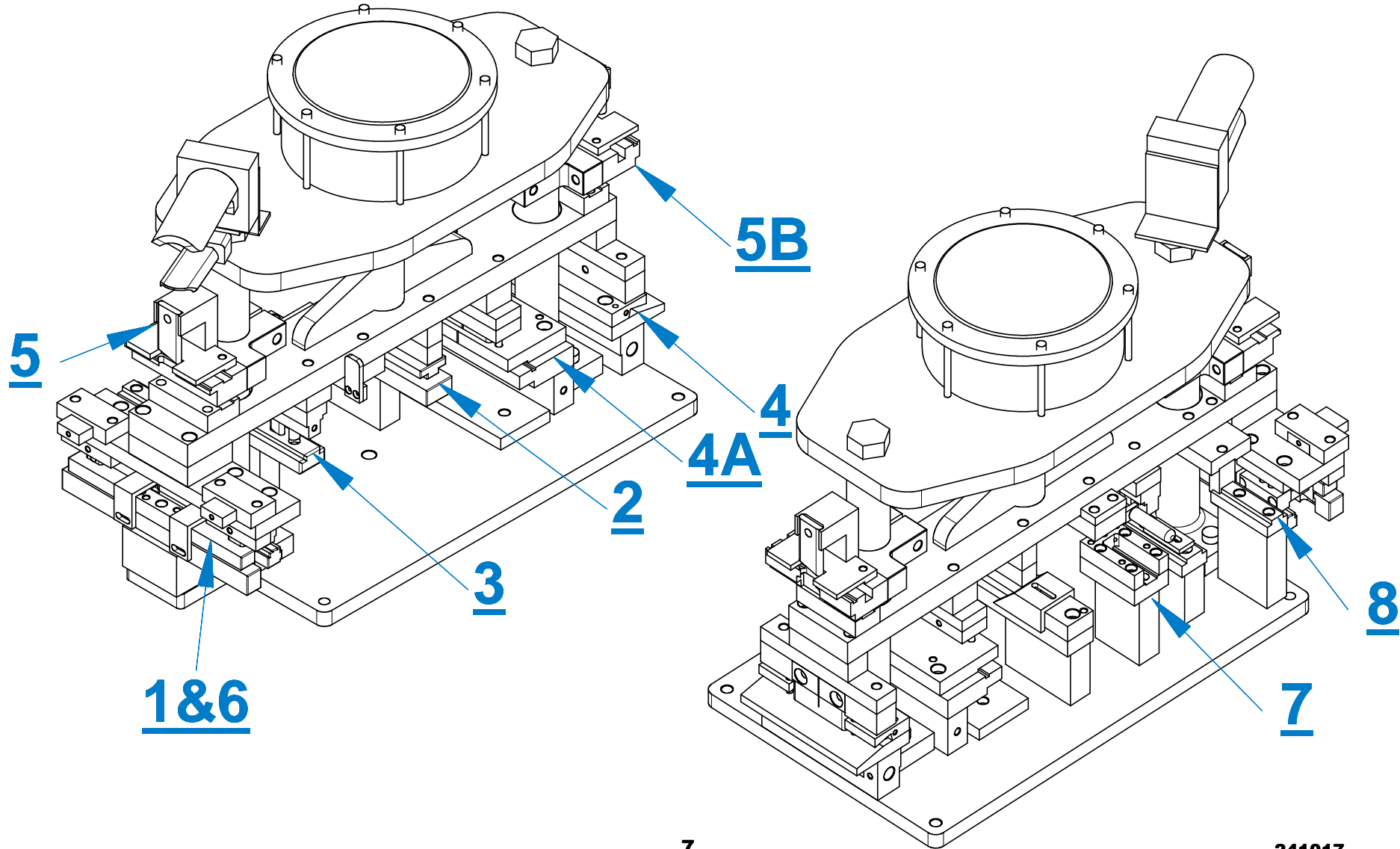



SHOHAM
MACHINERY LTD.

Model EXPLORER

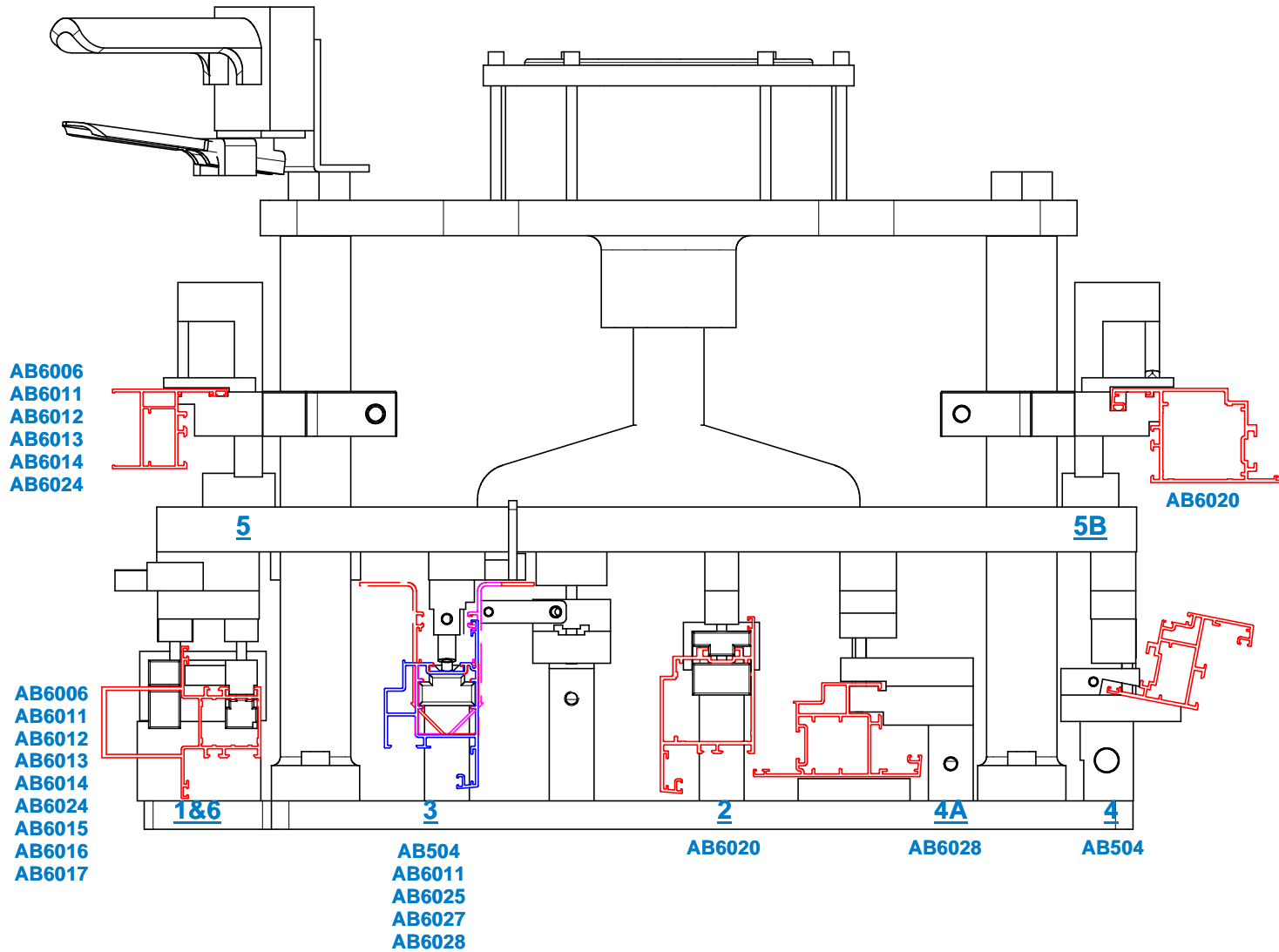

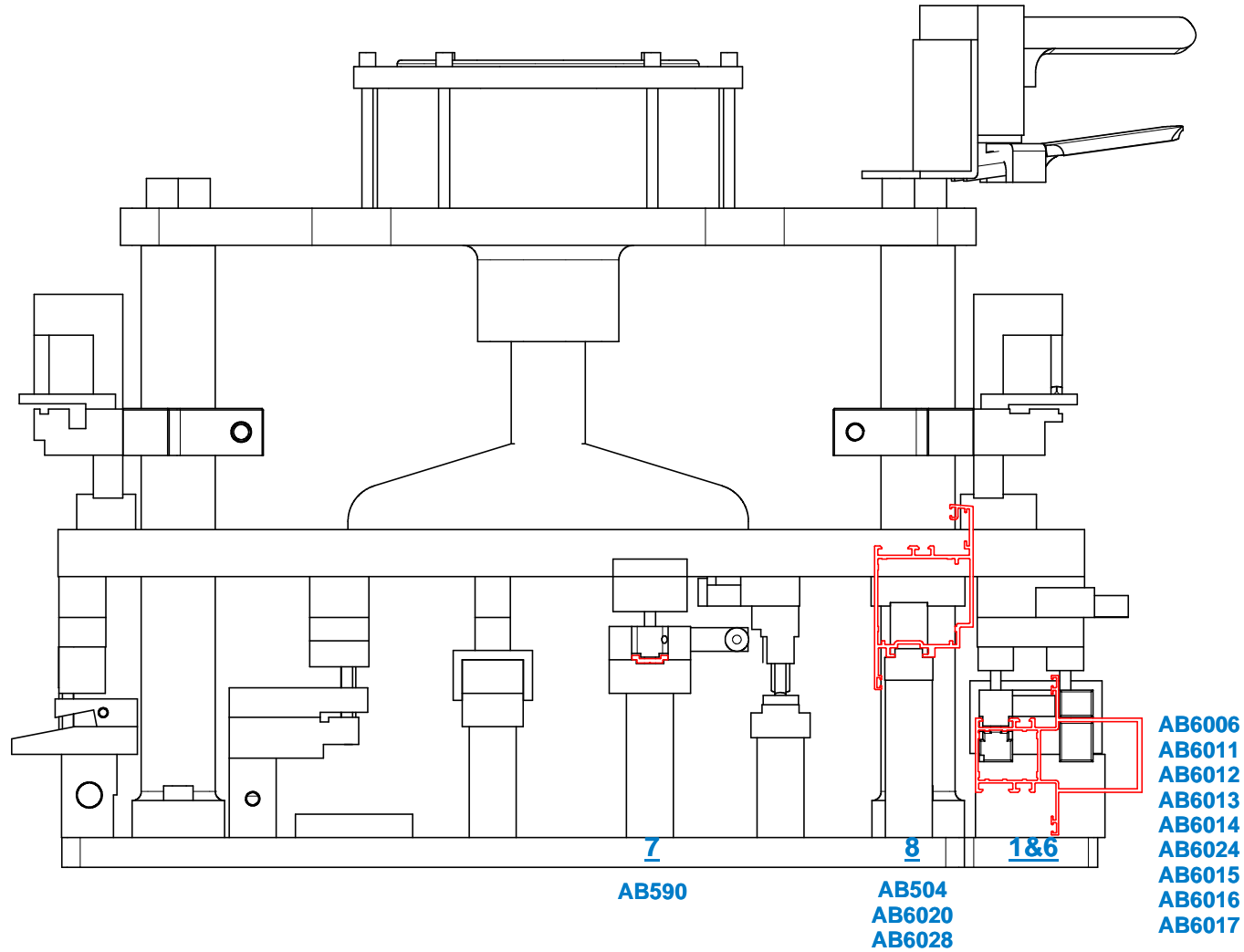



SHOHAM
MACHINERY LTD.

Model EXPLORER

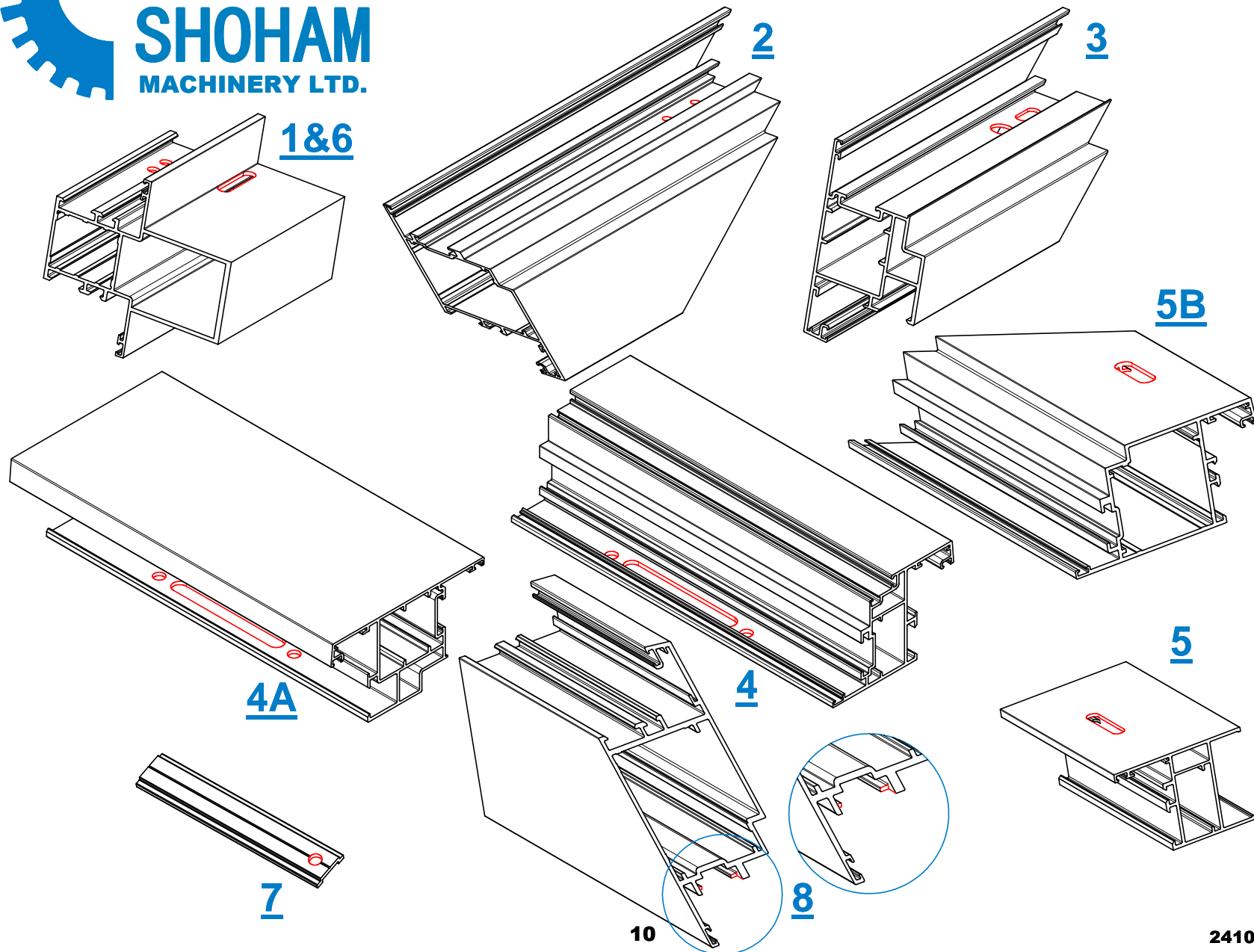

241017

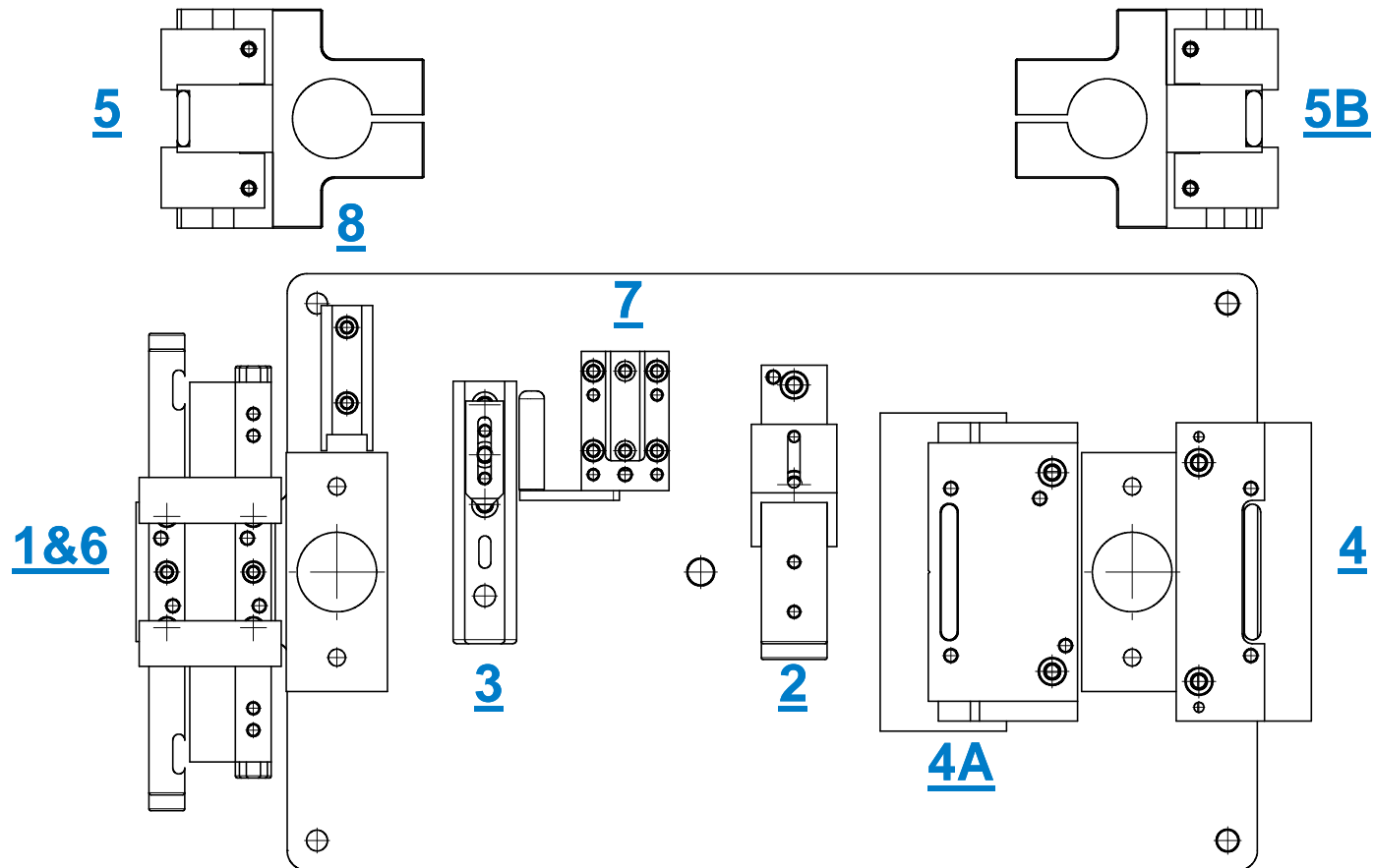

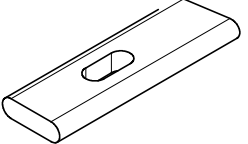
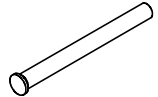
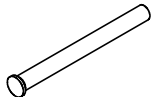
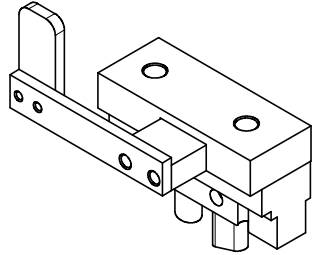
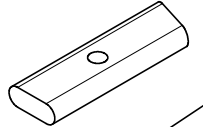
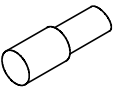
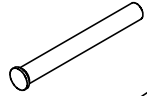
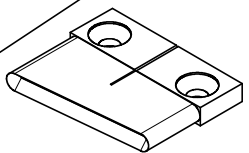
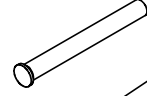
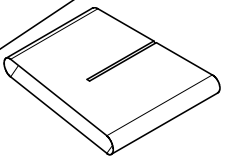
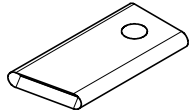
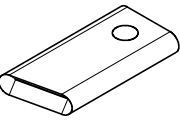
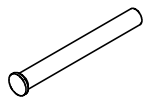
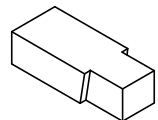
<p>Cutter: EXP-K01-13 - 2 units</p>  <p>1</p> <p style="writing-mode: vertical-rl; transform: rotate(180deg);">STATION No.1 & 6</p>	<p>Cutter: EXP-K01-15 - 4 units Ø5.5mm</p>  <p>2</p> <p style="writing-mode: vertical-rl; transform: rotate(180deg);">STATION No.1 & 6</p>	<p>Cutter: EXP-K02-6 - 2 units Ø5.5mm</p>  <p>3</p> <p style="writing-mode: vertical-rl; transform: rotate(180deg);">STATION No.2</p>	<p>Holders with cutters: EXP-H03-00</p>  <p>4</p> <p style="writing-mode: vertical-rl; transform: rotate(180deg);">STATION No.3</p>
<p>Cutter: EXP-K03-5</p>  <p>5</p> <p style="writing-mode: vertical-rl; transform: rotate(180deg);">STATION No.3</p> <p>Cutter: EXP-K03-6</p> 	<p>Cutter: EXP-K04-8 - 2 units Ø6.0mm</p>  <p>6</p> <p style="writing-mode: vertical-rl; transform: rotate(180deg);">STATION No.4</p> <p>Cutter: EXP-K04-5</p> 	<p>Cutter: EXP-K04A-9 - 2 units Ø6.0mm</p>  <p>7</p> <p style="writing-mode: vertical-rl; transform: rotate(180deg);">STATION No.4A</p> <p>Cutter: EXP-K04A-5</p> 	<p>Cutter: EXP-K05-5</p>  <p>8</p> <p style="writing-mode: vertical-rl; transform: rotate(180deg);">STATION No.5</p>
<p>Cutter: EXP-K05B-5</p>  <p>9</p> <p style="writing-mode: vertical-rl; transform: rotate(180deg);">STATION No.5B</p>	<p>Cutter: EXP-K07-6 - 1 unit Ø6.0mm</p>  <p>10</p> <p style="writing-mode: vertical-rl; transform: rotate(180deg);">STATION No.7</p>	<p>Cutter: EXP-K08-4</p>  <p>11</p> <p style="writing-mode: vertical-rl; transform: rotate(180deg);">STATION No.8</p>	